

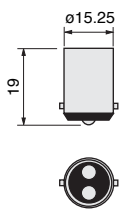
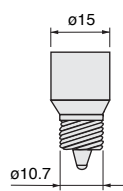
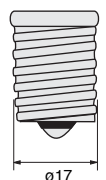
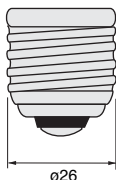
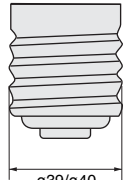
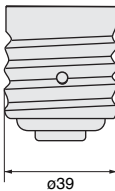
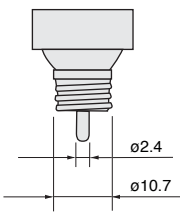
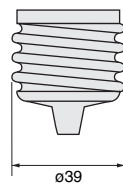
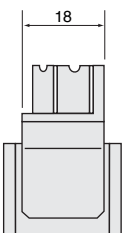
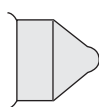
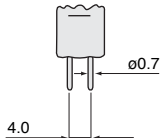
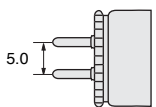
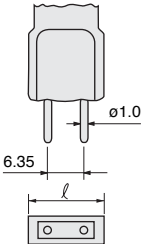
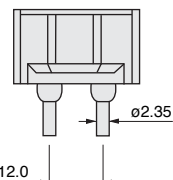
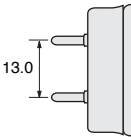
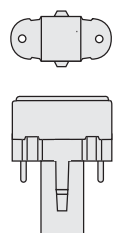
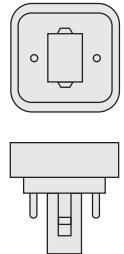
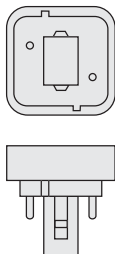
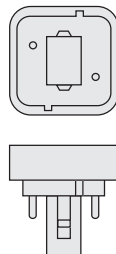
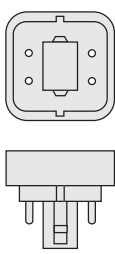
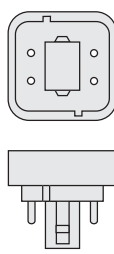
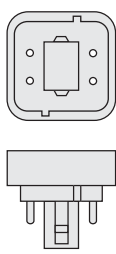
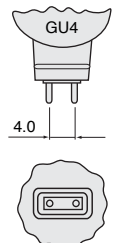
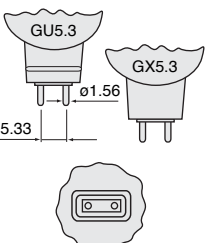
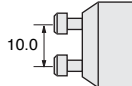
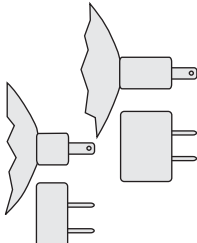
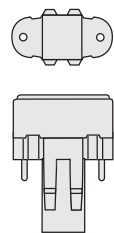
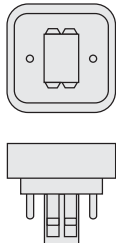
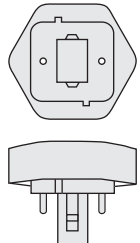
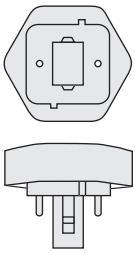
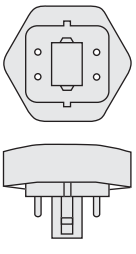
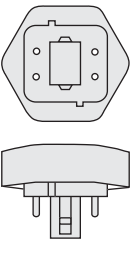
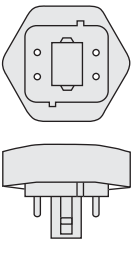
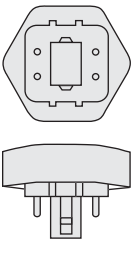
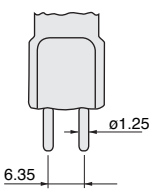
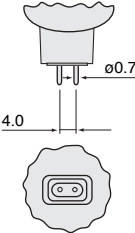
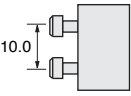
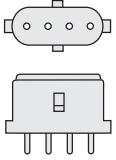
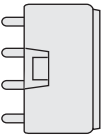
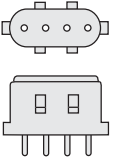
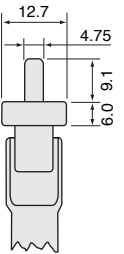
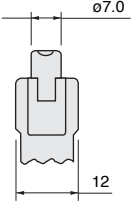

# LAMP BASE TYPES

BA9s	BA15d	E11	E17	E26	E39/E40
					
EP39	EU11	EX39	Fc2 / Fc2/18	FESTOON	G4
					
G5	G6.35	G12	G13	G23	G23-2
					
G24d-2	G24d-3	G24q-1	G24q-2	G24q-3	GU4
					
GU5.3 / GX5.3	GU10	GX16d	GX23	GX23-2	GX24d-2
					

GX24d-3	GX24q-1	GX24q-2	GX24q-3	GX24q-4	GY6.35
					
GZ4	GZ10	2G7	2G11	2GX7	Pin Blade
					
		R7s-12	RIGID LOOP	RX7s / RX7s-24	WEDGE
					

**LAMP FILAMENT TYPES**

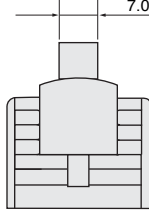
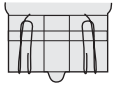
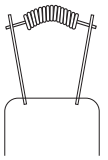
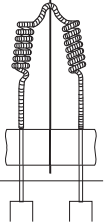
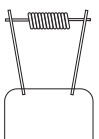
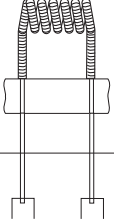
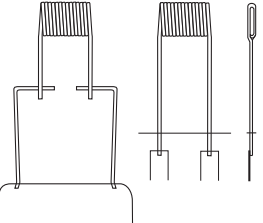
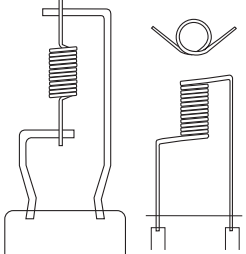
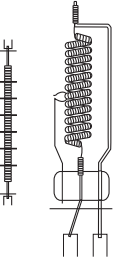
C-2R	CC-2V	C-6	CC-6	CBar6 (CF-6)	C8	CC-8
						

## Sockets for Single and Double Ended Quartz Halogen Lamps

Order Code	Description	Lead Wire Specs	Volts	Amps	Lamp Type
------------	-------------	-----------------	-------	------	-----------

### Sockets for Single Ended Halogen Lamps Miniature Bipin — 4.0mm Pin Spacing

#### G4 Base — 0.7mm Pin Diameter

1000108	C-14A	1.00X150L (Teflon Leads)	24V	3A	JC, MR-11
---------	-------	-----------------------------	-----	----	-----------

#### GZ4 Base — 1.0mm Pin Diameter

1000109	C-14B	0.75X150L	24V	3A	JC
---------	-------	-----------	-----	----	----

### 2-Pin Base — 5.33mm Pin Spacing

#### GX5.3 or GU5.3 Base — 1.6mm Pin Diameter

1002142	C-33U	0.75X150L	24V	7A	MR-16, GU5.3
1000114	C-5	1.25X160L	125V	15A	JCD, MR-16
1000115	C-5(A)	1.25X300L	125V	15A	JCD, MR-16

### 2-Pin Base — 12.0mm Pin Spacing

#### G12 Base — 2.35mm Pin Diameter

1000638	G12/3801	Screw Fixing			230L UHI
---------	----------	--------------	--	--	----------

### Minican Screw Base

#### E11 Base — 10.7mm Diameter Screw

1000683	J-12CS(A)	0.75X150L UL	125V	6A	JCV
---------	-----------	--------------	------	----	-----

#### EU11 Base — 2.4mm Diameter Screw

1003222	EU-11FS	0.65X5X3X8 UL3068	120V	5A	JDW
1003223	EU-11GS	0.65X5X3X8 UL3068	120V	5A	JDW

### Sockets for Double Ended Halogen Lamps Recessed Single Contact Base

#### R7S Base — 7.0mm Base Diameter

1000110	C-16	W/O Leads	250V	10A	J, JP, JPD
1000117	C-8	2.00X150L	250V	10A	J, JP, JPD
1000677	J-1	2.00X300L UL	250V	10A	J, JP, JPD



C-33U



C-5(A)



G-12/3801



C16



EU-11FS/EU-11GS



C8



J-1